

ControlLinks™ Fuel Air Ratio Control System

A GUIDE SPECIFICATION FOR THE ENGINEER

A. GENERAL

A.1 Overview

For each burner, the contractor shall furnish, install and place in operating condition a microprocessor based fuel air ratio control system. The control system shall be provided by Honeywell, Inc.

A.2 Type of System

The Fuel Air Ratio Control System shall utilize signal inputs from the firing rate control, stack or water temperature sensor and the burner management control to control the relationship between fuel, airflow and flue gas recirculation (if used) on a full modulation power burner. Up to four (4) independently controlled positioning actuators shall be commanded by the control. Actuators control damper positioning for air and flue gas and valve positioning for the primary and secondary fuels.

A.2.1 Major Features of the Fuel Air Ratio Control:

- a. Four (4) channel output control.
 - Two fuels.
 - Combustion Air.
 - Flexible Use: Flue Gas Recirculation (FGR), Secondary Air Control or Secondary Modulating Valve.
- b. Two (2) independent fuel profiles.
- c. 950 actuator positions per channel.
- d. Fast burner setup via System Display or PC/laptop running Configuration software. Password protected.
- e. Maximum 24 point profile per fuel type.
- f. Quick set-up feature providing minimum 3 point profile curve.
- g. Programmable behavior of non-selected fuel actuator.
- h. Programmable behavior of all actuators during purge and standby.
- i. Independent light-off, minimum modulation and maximum modulation position for each fuel profile.
- j. Model A: voltage input range of 85 to 132 Vac, 45 to 66 Hz.
- k. Model B: voltage input range of 170 to 264 Vac, 45 to 66 Hz.
- l. Auto/Manual input.
- m. Manual mode firing rate input.
- n. Pluggable controller to wiring subbase.
- o. Configurable hysteresis of 0.12mA to 3.0mA and configurable dead band adjustment from 0.1 to 0.5 angular degrees.
- p. Integrated boiler shock protection algorithms:
 - Water or Stack temperature low fire hold.
 - FGR (Flue Gas Recirculation) hold based on stack or water vessel temperatures.
 - FGR and low fire hold.
- q. Maximum modulation limit capability.
- r. Remote reset input
- s. Automated actuator endpoint seeking process.
- t. Nonvolatile memory stores current lockouts, alarm status and operating history (last six faults).
- u. Six (6) status light-emitting diodes (LEDs):
 - System status (green).
 - Fault information (red).
 - Status of four actuator channels (amber).
- v. Operating temperature range: -40°F to +140°F (-40°C to +60°C).
- w. Blink fault code generation using reset button.
- x. Seamless system integration with 7800 SERIES Burner Control.
- y. Functional with competitive full modulation burner controls.
- z. Alarm output.



A2.2 Major Features of the Positioning Actuator:

- a. Universal power supply of 85 to 264 Vac, 45 to 66 Hz.
- b. Password protected with an eight (8) digit identification number.
- c. 100 lb-in torque, 30 second timing, 95 degree stroke.
- d. Direct coupled output.
- e. External indication of actuator position via large arrow.
- f. Floating current control input.
- g. Output hub position accuracy of ± 0.1 angular degrees.
- h. NEMA 2 protection rating.
- i. Operating temperature range: -40°F to $+140^{\circ}\text{F}$ (-40°C to $+60^{\circ}\text{C}$).
- j. Separate low and line voltage wiring compartments.
- k. NEMA 3 kit available.
- l. CW and CCW switches for manually driving hub.
- m. Feedback potentiometer circuitry.

A.2.3 Major Features of the System Display:

- a. Upload commissioned data.
- b. Real time graphing of commissioned points.
- c. Flexible point creation and editing.
- d. Diagnostic capabilities.
- e. Download of existing profiles.
- f. 100-240 Vac universal power input power supply included.
- g. Operating temperature range: $+14^{\circ}\text{F}$ to $+122^{\circ}\text{F}$ (-10°C to $+50^{\circ}\text{C}$).
- h. Commission the Fuel Air Ratio Control System.
- i. Password protection for commissioning, setpoint changes and remote reset.
- j. Off-line profile curve building.
- k. Real-time data trend graphing, totalization and bar graphing of key process variables.
- l. Configure a Modbus® Network of up to 99 nodes and assign names.
- m. Monitor the Fuel Air Ratio Control and a burner/ boiler network.

- n. LED indicators for Power, Network, COM 2 and COM 1.
- o. Two RS-485 communication ports and one Ethernet port.
- p. Flush mounting.
- q. Free software upgrades available via the internet.
- r. Store up to 10 fuel profile curves.
- s. Touch screen with full screen color graphics and graphic user interface.
- t. Touch screen disable for screen cleaning.
- u. Audio feedback with volume control.

A.2.4 Major Features of the Configuration Software:

- a. Windows 95, 98 or 2000 compatible.
- b. Upload of commissioned data.
- c. Real time graphing of commissioned points.
- d. Flexible point creation and editing.
- e. Diagnostic capabilities.
- f. Download of existing profiles.

A.2.5 System Components:

- a. Fuel Air Ratio Controller
- b. Wiring Subbase
- c. Positioning Actuator
- d. System Display or
- e. Configuration software

A.2.6 Optional Components:

- a. Combustion Analyzer
- b. Port Expander
- c. RS-232/RS-485 Converter
- d. Spare 3-Pin RS-485 Electrical Connector

A.3 Wiring

A.3.1 The Fuel Air Ratio Control Wiring Shall be in Accordance with the National Electrical Codes (NEC) and Local Electrical Codes.

B. SYSTEM OPERATION

B.1 Safety Provisions

B.1.1 The Fuel Air Ratio Control Shall Provide the Following Safety Provisions:

- a. Dynamic self check of the feedback potentiometer circuitry. The Fuel Air Ratio Control microprocessor tests the feedback from the Positioning Actuator and will lockout on safety shutdown if the feedback test fails.
- b. Curve verification algorithms. After the service technician has built the fuel/air curve for the burner, the fuel/air control requires that the curve is verified. This verification is a check that all points on the curve are at the optimum fuel air profile position.
- c. Step size enforcement during commissioning. During the commissioning process of the Fuel Air Ratio Control, the movement of the Positioning Actuator is limited to a maximum of 3 degrees up to 20% of the actuator stroke. This prevents the service technician from accidentally entering fuel rich/lean territories.
- d. Point plausibility algorithms. During the commissioning process, the Fuel Air Ratio Control will check the points that are entered to build the curve. If the point is not acceptable, a crosshair with a diamond will be shown and the point won't be allowed to be entered.
- e. Password protection. The Fuel Air Ratio Control requires a password to commission the burner profile. The Fuel Air Ratio Control can be monitored without a password. This safety feature is used to prevent unauthorized personnel from changing the configured/verified burner profile.
- f. Safety Relay Test/Weld-resistant algorithm for limit control input (LCI) and limit control output (LCO) contacts. Dynamic algorithm check of the LCI and LCO relay contacts for weld/short-circuit. This safety feature will cause a safety shutdown and lockout of the Fuel Air Ratio Control.
- g. Component anti-swap protection. The Fuel Air Ratio Control is programmed with the identification number on the Positioning Actuator. This safety feature prevents the installation of the actuators that have not been configured for the burner application.
- h. Curve tracking verification/Off-curve checking algorithm. Dynamic algorithm checks the feedback of the fuel/air actuators against the burner profiled curve. If an actuator is off the curve and cannot be repositioned on the curve, a safety shutoff and lockout will occur.

- i. Integrated Thermal Shock Protection Algorithms.
 - Water or Stack Temperature Low Fire Hold. Based on a scalable 4-20mA auxiliary sensor input, the burner is held at light-off until the programmed temperature threshold is exceeded.
 - FGR Hold. Based on a scalable 4-20mA auxiliary sensor input, the FGR damper is kept closed until the stack temperature has reached its programmed threshold.
 - FGR and Low Fire Hold Combined. Performs both the Water or Stack Temperature Low Fire Hold and the FGR Hold algorithms.

B.2 Annunciation and Diagnostics

B.2.1 The Fuel Air Ratio Control Shall Provide:

- a. First-out annunciation of fault occurrence.
- b. Indication of sequence failures at start-up or during normal sequence operation.
- c. Test of itself for failure, detecting and isolating an alarm, and reporting internal circuit faults.
- d. System fault log history of the last six (6) faults.
- e. Six (6) status LEDs for Power, Alarm and four (4) actuators.
- f. Blinking fault code generation on Power LED using reset button (60 possible codes).
- g. Alarm LED indicates lockout alarm condition.

B.2.2 The Positioning Actuator Shall Provide:

- a. LED annunciation for actuator Unconfigured, Configured and On-Line or Faulty actuator states.
- b. Actuator CW and CCW switches for manually driving hub for troubleshooting.

B.2.3 The System Display or Configuration software Shall Provide:

- a. HMI (Human Machine Interface) for commissioning of the Fuel Air Ratio Control.
- b. First-out annunciation of fault occurrence.
- c. Indication of sequence failures at start-up or during normal sequence operation.
- d. System fault log history with date/time stamping of last six (6) faults.
- e. Fault code displayed on screen (60 possible codes).
- f. Audio feedback of alarm condition (with volume control).
- g. Status of the Fuel Air Ratio Control and Positioning Actuators.

C. MAJOR EQUIPMENT

C.1 System Specifications

C.1.1 Temperature:

- a. Fuel Air Ratio Control and Positioning Actuators shall be able to operate in a -40°F to +140°F (-40°C to +60°C) temperature range environment. The components should be able to be shipped and stored in a -40°F to +150°F (-40°C to +66°C) temperature range environment.
- b. System Display shall be able to operate in a +14°F to +122°F (-10°C to +50°C) temperature range environment. The component should be able to be shipped and stored in a -13°F to +155°F (-25°C to +60°C) temperature range environment.

C.1.2 Humidity:

- a. Fuel Air Ratio Control, Positioning Actuators and System Display shall be able to operate in an 95% RH continuous, non-condensing environment.

C.1.3 Vibration:

- a. Fuel Air Ratio Control and Positioning Actuators shall be able to operate in a 0.5G continuous environment.
- b. System Display and Configuration software are not rated for operation in a vibrational environment.





C.1.4 Electrical Ratings:

- a. Fuel Air Ratio Control model A will operate in a 100 to 120 Vac (+10/-15%), 50/60 Hz ($\pm 10\%$) environment.
- b. Fuel Air Ratio Control Model B will operate in a 200 to 240 Vac (+10/-15%), 50/60 Hz ($\pm 10\%$) environment.
- c. Positioning Actuator will operate in a 100 to 240 Vac (+10/-15%), 50/60 Hz ($\pm 10\%$) environment.
- d. System Display will operate in a 100 to 240 Vac (+10/-15%), 50/60 Hz (+5/-6%) or 120-370 Vdc environment to its power supply.

C.1.5 Codes, Standards and Approvals:

- a. Fuel Air Ratio Control model A shall have the following approvals:
 - UL/cUL Component Recognized
 - CE Approved
 - CSD-1 Acceptable
 - NFPA Acceptable
 - AGA (Australian Gas Association) Certified Product
- b. Fuel Air Ratio Control model B shall have the following approvals:
 - CE Approved
 - CSD-1 Acceptable
 - NFPA Acceptable
 - AGA (Australian Gas Association) Certified Product
- c. Positioning Actuator shall have the following approvals:
 - UL/cUL Listed
 - CE Approved
 - AGA (Australian Gas Association) Certified Product
- d. System Display shall have the following approvals:
 - UL Listed
 - FCC (Part 15, Class A digital device)
 - Canadian ICES-003
- e. Configuration software does not require such ratings.

C.2 Component Model Description

Component and Description		Function
<p>R7999A,B</p> 	ControlLinks™ Fuel Air Ratio Controller	The R7999 is a microprocessor-based control that simultaneously directs up to four UPPAs (Universal Parallel Positioning Actuators), based on input from the Firing Rate Control, Limit and Operating Controls, Primary Flame Safeguard Control and/or the S7999B System Display. Provides for two independent fuel profiles. The control generates fault messages and annunciations, stores operating history and shows status of power, alarm and UPPAs via LEDs. The ControlLinks™ Controller, along with the UPPAs, maintains optimal burner Fuel Air Ratio to maximize burner efficiency and minimize fuel usage and emissions. R7999A: Meets North American and international approvals. 100-120Vac. R7999B: Meets international approvals. 200-240Vac.
<p>ML7999A</p> 	Universal Parallel Positioning Actuator (UPPA)	Drives combustion air dampers, gas valves, oil valves and flue gas recirculation system dampers based on input from the R7999 ControlLinks™ Control. Provides fuel and air in proper proportion and varies burner firing rate to meet the load demand.
<p>Q7999A</p> 	Wiring Subbase	Provides terminals for field wiring. Line voltage and low voltage wiring is separated on the wiring subbase and prevents the incorrect installation of the ControlLinks™ Control.
<p>S7999B System Display</p> 		<p>Commission</p> <ul style="list-style-type: none"> ControlLinks™ Fuel/Air Ratio Control System. Password protected. <p>Configure</p> <ul style="list-style-type: none"> S7830 Expanded Annunciator Terminal Names (Global Feature) Modbus Network (up to 99 nodes) & Assign Names <p>Monitor</p> <ul style="list-style-type: none"> (Local) Burner/Boiler System or up to 99 Systems/Nodes Device status, fault codes & history, diagnostic information and key process variables for each 7800 SERIES & R7140 Burner Control, ControlLinks™ Fuel/Air Ratio Control, Expanded Annunciator and/or UDC controller. <p>Control</p> <ul style="list-style-type: none"> Single (Local) Burner/Boiler System or up to 99 Systems/Nodes Remote reset for each 7800 SERIES & R7140 Burner Control. UDC device security password, control, demand & alarm setpoints. Password protected.
<p>ZM7999A</p>	Configuration software	Support software for IBM-equivalent personal or laptop computers that use Microsoft™ Windows software. Provides commissioning and monitoring capability as well as online help information on the operating system.

Further Information	Installation Instructions	Product Data	Guide Spec	Technical Brochure
• R7999A, B Controller	-	65-0238	65-0248	63-9489
• Q7999A Wiring Subbase	-	65-0240	65-0248	63-9489
• ML7999A Parallel Positioning Actuator	66-1121	65-0239	65-0248	63-9489
• S7999B System Display	65-0283	-	65-0293	63-9488
• ZM7999A Configuration software	-	65-0242	-	-
• Download from: http://customer.honeywell.com				

C.3 Optional Component Description

Component & Description		Function
A7999A	Portable Combustion Analyzer	Portable hand held combustion analyzer (PCA). For sampling combustion gases of furnaces, appliances and boilers during the ControLinks™ commissioning process. The basic instrument is supplied with a probe, instruction manual, batteries, and carrying case. If using ZM7999A Configuration software, PCA data can be shown on the screen. The PCA communicates via RS-232 protocol, with a personal computer running ZM7999A software. For the commissioning process, a port expander (32005354-001) will be required as well as any associated cabling. Also, a USB/RS-232 converter may be required along with any associated cabling, depending on the PC communication protocol configuration.
32005354-001	Port Expander	RS-485 to RS-232 port expander for use during ControLinks™ commissioning process with ZM7999A software. One RS-485 port and two RS-232 ports to be used with the A7999A Combustion Analyzer and a PC running the ZM7999A Configuration software. Includes a 3-pin RS-485 electrical connector.
QM4520A1004	RS-232 to RS-485 Converter	Converter for use during ControLinks™ commissioning process with a PC that has RS-232 communication protocol and is running the ZM7999A Configuration software. The R7999A,B ControLinks™ Controller requires RS-485 input.
32002515-001	3-Pin RS-485 Electrical Connector	Spare 3-pin RS-485 electrical connector for the R7999A,B and/or the Port Expander (32005354-001).

Further Information	Installation Instructions	Product Data	Guide Spec	Technical Brochure
<ul style="list-style-type: none"> QM4520A1004 RS-232/RS-485 Converter 	-	65-0211	-	-
<ul style="list-style-type: none"> Download from: http://customer.honeywell.com 				





C.4 Condensed Specifications

Condensed Specifications	
Application	<ul style="list-style-type: none"> Linkageless Fuel Air Ratio Control System 4 Channel Output Control: Combustion Air, Fuel 1, Fuel 2, Flexible Usage 4th Channel Usage: FGR, Secondary Air Control, Secondary Modulating Fuel Valve Integrated Thermal Shock Protection Algorithms for Low Fire Hold and/or FGR Hold
LED Indicators, R7999A,B	Power/Alarm/4 Motor Channels for Status and Fault Codes (60 Possible)
Protection Category	R7999: NEMA 1 (IP40) ML7999: NEMA 2 (IP31) or NEMA 3 (IP54) with Optional Weatherproof Kit
Hysteresis and Dead Band	Configurable from 0.12 mA to 3.0 mA and 0.1 to 0.5 Angular Degrees
Required Components	ML7999A Universal Parallel Positioning Actuator (quantity 2 to 4), R7999A,B Controller, Q7999A Wiring Subbase and S7999B System Display or ZM7999A Configuration software (for commissioning and/or monitoring)
Optional Components and Accessories	Weatherproof Kit (NEMA 3/IP54) for ML7999A, Shaft Adapters, A7999A Portable Combustion Analyzer & Port Expander RS-232/RS-485 (for commissioning) & ControlLinks™ Demo Tool: DSP3548
Electrical Ratings	R7999A: 100 to 120 Vac (+10%, -15%), 50/60 Hz (±10%), 10VA maximum R7999B: 200 to 240 Vac (+10%, -15%), 50/60 Hz (±10%), 10VA maximum ML7999A: 100 to 240 Vac (+10%, -15%), 50/60 Hz (±10%), 15VA maximum S7999B: 100 to 240 Vac (+10, -15%), 50/60 Hz (+5, -6%) or 120-370 Vdc
Vibration	R7999A,B and ML7999A: 0.0 to 0.5 G continuous environment S7999B or ZM7999A: Not Applicable
Actuator Stroke	95° nominal ±3°, mechanically limited
Actuator Timing	24 to 30 seconds for 90° Travel
Actuator Torque	100 lb-in (11.3 Nm) Lift and Hold Minimum, Breakaway Minimum, Stall Minimum
Actuator Accuracy	Output Hub Position Accuracy ±0.1 Angular Degrees
Ambient Temperature Range	R7999A,B and ML7999A: -40°F to +140°F (-40°C to +60°C) S7999B: +14°F to +122°F (-10°C to +50°C)
Humidity Range	5% to 95% Relative Humidity, Non-condensing
Dimensions	R7999A,B: 5-3/16 in. w x 7-3/16 in. h x 3 in. d installed (131mm w x 182mm h x 76mm d) ML7999A: 4 in. w x 6 in. h x 3-1/2 in. d (102mm w x 153mm h x 89mm d) S7999B: 9-13/32 in. w x 6-21/32 in. h x 1-9/16 in. d (239mm w x 169mm h x 40mm d)
Approvals	R7999A: UL/cUL Component Recognized, CE Approved, CSD-1 & NFPA Acceptable, AGA (Australian Gas Association) Certified Product R7999B: CE Approved, CSD-1 & NFPA Acceptable, AGA Certified Product ML7999A: UL/cUL Listed, CE Approved, AGA Certified Product S7999B: UL Listed, FCC (Part 15, Class A digital device), Canadian ICES-003

D. HONEYWELL COMPATIBLE COMPONENTS

D.1 Listing of Honeywell Components Compatible with Honeywell ControlLinks™ Fuel Air Ratio Control System

The following components may be used in conjunction with the Honeywell ControlLinks™ Fuel Air Ratio Control System on any full modulation burner.

Component & Description		Function
	V5197A Firing Rate Valve	Modulating valve comes with ML7999 mounting bracket and direct couple drive stem to facilitate set-up. Driven by ML7999A, which responds to firing rate commands provided to the R7999 Controller, the valve expertly helps you match the appliance load. 15psi maximum rating, visual position indicator. Accepts C6097 flange mounted pressure switch. Several pipe adapters are available for valve train installation. Provides turndown of up to 40:1 via its flow limiting adjustment.
	C6097 Gas/Air Pressure Switch	Diaphragm-actuated Gas Pressure Limit Switch. Available in 1/4 in. NPT or flange mount models, which mount directly to the V5197A Firing Rate Valve. IP54 enclosure standard. Other variations include additive or subtractive differential, operating pressure range, maximum pressure, manual reset and break on pressure fall or rise.
	P7810C PressureTrol® Controller	Combination Firing Rate/Limit/On-Off Control. Two separate sensors for Limit and On-Off/ Firing Rate Control. Provides 4-20mA Firing Rate commands based on pressure to the ControlLinks™ Controller for effective load matching. For use with steam, air or noncombustible gases. Various operating pressure and differential ranges available. Break on pressure rise. LED indicators for power, call for heat and lockout status. Manual reset and electronic maximum fixed stop limit.
	RM7800 SERIES Primary Flame Safeguard Controls	Primary flame safeguard control family. Several variations available for standing, intermittent or interrupted pilots, on/off or programming, modulation, pre purge, post purge, proof of closure, valve proving system (VPS), and lockout or recycle modulation as well as many other options.
	UDC2500 or UDC3200 Controller	For Firing Rate and/or On/Off operation based on pressure or temperature, the UDC2500 or UDC3200 Controls are just the ticket, providing accurate command for your burner application. For Firing Rate, controls provide a 4-20mA output for the ControlLinks™ Controller.

Further Information	Installation Instructions	Product Data	Technical Brochure
V5197A Firing Rate Gas Valve	-	65-0247	-
C6097 Pressure Switches	-	65-0237	-
P7810C PressureTrol® Controller	-	65-0285	-
7800 SERIES Flame Safeguard Controls	Various	Various	63-9501 63-9502 63-9503 63-9504 63-9505
Download from: http://customer.honeywell.com			
UDC2500/UDC3200 Universal Digital Controls	http://content.honeywell.com/imc/pi/		

D.2 Application Example—Boiler Application

Boiler Application — ControlLinks Fuel Air Ratio Control System

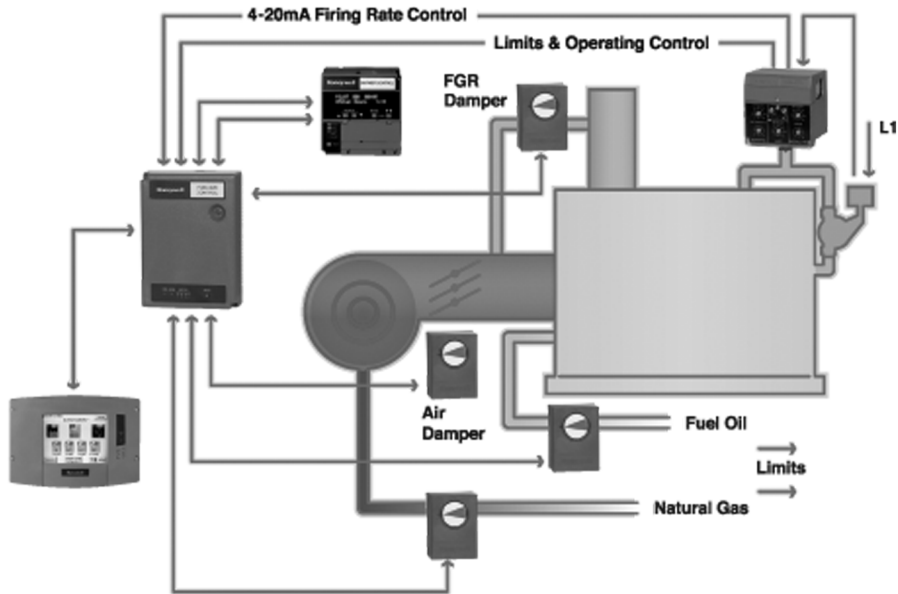

D.2.1 ControlLinks™ Fuel Air Ratio Control Application Notes:

- a. For use only on a full modulating power burner.
- b. ControlLinks™ can operate two independent fuel valves, for dual fuel applications. However, only one valve may be operated at a time, corresponding to its applicable fuel air profile curve.
- c. FGR Damper as shown in diagram used with Flexible Use 4th Channel function for Flue Gas Recirculation.

Automation and Control Solutions

Honeywell International Inc.
1985 Douglas Drive North
Golden Valley, MN 55422
customer.honeywell.com

Honeywell Limited-Honeywell Limitée
35 Dynamic Drive
Toronto, Ontario M1V 4Z9

