

Table of Contents

Table of Contents Page 1
 Approvals Page 1
 Attention Page 1
 Specification Page 2
 Model Description & Part Number Page 2
 Mounting and Pressure Connection..... Page 3
 Wiring Page 3
 Operation Page 3
 Adjustment & Reset Page 4
 Installation Position Page 4
 Dimensions Page 5
 Maintenance & Testing Page 5
 Accessories & Replacement Page 6



Approvals



CSA Certified:
 CSA C22.2 No.14
 CSA C22.2 No.0
 UL 508
 File # 2620681

Attention



The installation and maintenance of this product must be done under the supervision of an experienced and trained specialist. Never perform work if gas pressure or power is applied, or in the presence of an open flame.



Check the ratings in the specifications to verify that they are suitable for your application.



Please read the instruction before installing or operating. Keep the instruction in a safe place. You find the instruction also at www.dungs.com. If these instructions are not heeded, the result may be personal injury or damage to property.



On completion of work on the pressure switch, perform a leakage and function test.



Any adjustment and application-specific adjustment values must be made in accordance with the equipment manufacturers instructions.



This product is intended for installations covered by, but not limited to, the following fuel gas codes and standards: NFPA 54 or IFGC (International Fuel Gas Code) or the following equipment codes and standards: NFPA 37, NFPA 85, NFPA 86, ANSI Z83.4/CSA 3.7, ANSI Z83.18/CSA 4.9, ANSI Z21.13, CSD-1.

Explanation of symbols

- 1, 2, 3 ... = Action
- = Instruction

Specification

GW...HP SGS High/Low ventless gas pressure switch (SPDT). Pressure acts via the diaphragm against the force of the setting spring on the microswitch. The pressure switch operates without any auxiliary power.



Max. Operating Pressure (MOP)
 GW 500 2* bar (30 PSI)
 GW 500 5* bar (75 PSI)
 GW 2000 5 bar (75 PSI)
 GW 6000 8 bar (120 PSI)
 2* bar @ setting 0.1 - 0.15 bar
 5* bar @ setting 0.15 - 5 bar
 * to stay within the switch setting tolerance over the useful life of the switch.

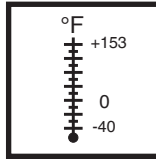

Ambient / Medium Temperature
 Ambient: +5 °F ... +158 °F
 (-15 °C ... +70 °C)
 Medium: +5 °F ... +158 °F
 (-15 °C ... +70 °C)
 Storage: -22 °F ... +185 °F
 (-30 °C ... +85 °C)

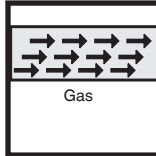

Gases
 Dry, natural gas, propane, butane; other noncorrosive gases.

Suitable for biogases up to 1.0 % by volume, wet H₂S at +35 °C (subject to gas analysis of the installation) and flue gases of biogas installations up to 0.1 % by volume, wet SO₂ at +35 °C.



Electrical Connection
 Screw terminals via M 20 x 1.5 conduit connection

Proven suitability for barn atmosphere in accordance with DIN EN 60730-2-9.

When used with biogas, warranty is limited to one year from date of installation.

Switching voltage
Standard application
 ~ (AC) eff. min. 24 V
 ~ (AC) max. 250 V
 = (DC) min. 24 V
 = (DC) max. 48 V
Rated current
 Standard application: ~ (AC) 10 A
 DDC application: = (DC) 20 mA
Switching current
Standard application
 ~ (AC) eff. min. 20 mV
 ~ (AC) max. 6 A at cos φ 1
 ~ (AC) max. 3 A at cos φ 0.6
 = (DC) min. 20 mA
 = (DC) max. 1 A
DDC application (low voltage)
 = (DC) min. 5 mA
 = (DC) max. 20 mA

Materials in contact with Gas Pressure connection / Metal bellow

Stainless steel DIN 1.4541
Cover
 Zinc diecast, powder-coated
Switch part
 tin-plated
Switching contact
 Silver (Ag), galv. gold-plated (Au)

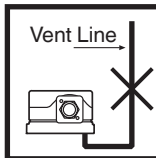

Atmospheric Vent Connection
 Switch does not incorporate an atmospheric diaphragm. Switch actuates via metallic bellow. No venting required when accepted by the authority having jurisdiction.

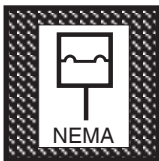

Enclosure
 IP 65 acc. IEC 529 (EN 60529)



Switch
 SPDT
Switch action
 Pressure, positive

Model Description & Part Number

Type	Version	P _{max.} bar [PSI]	Order No.	Adjusting range bar [PSI]	Switching hysteresis Δp bar [PSI]	Factory Calibration
Gas pressure switch	GW 500 A4/2 HP SGS	2 @ 0.1 - 0.15 [1.5 - 2.0] 5 @ 0.15 - 0.5 [2.0 - 7.0]	273274	0.1 - 0.5 [1.5 - 7.0]	≤ 0.03 [0.5]	
	GW 2000 A4/2 HP SGS	5 [75]	273275	0.4 - 2.0 [6 - 30]	≤ 0.05 @ 0.4 - 1 [0.05 @ 6 - 15] ≤ 0.1 @ > 1 - 2 [1.5 @ 15 - 30]	
	GW 6000 A4/2 HP SGS	8 [120]	255576	1.0 - 6.0 [15 - 85]	≤ 0.3 [4.5]	

Mounting and Pressure Connection

Threaded Connection

- 1 Pressure connection (+) 1/4 G, Gas or Air.
(1/4 G to 1/4" NPT adapter with gasket Order No. 231944)

Mounting Procedure

- Apply suitable pipe sealant to the male threads only.
- Use 13/16" Wrench to secure the switch to the pipe.
- **DO NOT Exceed 177 lb-in of Torque on 1/4" Connections**
- After installation is complete, perform a leak test.

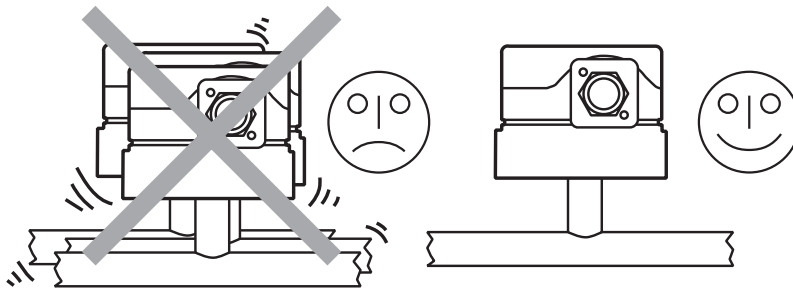
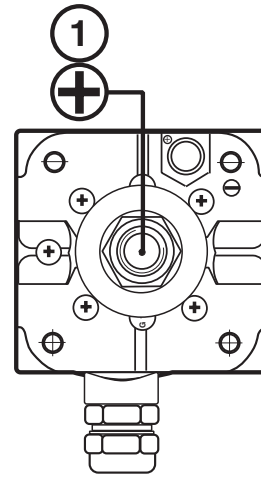

Wiring

1. Remove the cover from the switch.
2. Use 14 or 16 AWG wire rated for at least 75 °C.
3. Route the wires through the conduit connector.
4. Connect the wiring to the appropriate screw terminals.
5. Replace the clear cover from the switch.

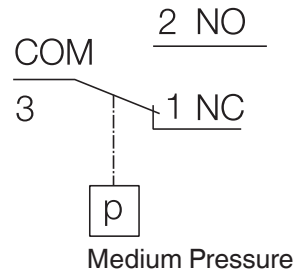

Switching function

As pressure rises above setpoint:
1 NC opens, 2 NO closes

As pressure falls below setpoint:
2 NO opens, 1 NC closes

All wiring must comply with local electrical codes, ordinances and regulations.

Do not exceed the switch ratings given in the specifications and on the switch.

Operation

Definition of switching hysteresis Δp

The pressure difference between the upper and lower switching pressures.

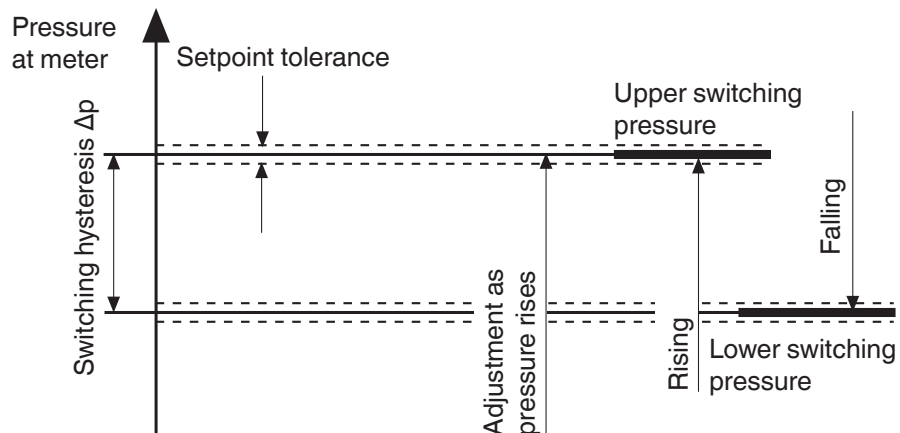

Adjustment & Reset

Adjusting the Set Point

1. Remove the cover ❶ from the switch.
2. Adjust the switch to the desired set point by turning the dial.
The arrow on the dial indicates the set point ❷. The arrow might not indicate the actual set point due to two factors. One is the set point tolerance of the switch, which can be $\pm 15\%$ of the set point. Another one is the mounting position. See section "Installation Position" to account for the difference in actual set point due to mounting position.

↑ Arrow indicates set point when used as high gas switch

↓ Arrow indicates set point when used as low gas switch

Note: Allowable drift of set point after 250,000 cycles $\pm 15\%$.

3. After adjusting the set point, verify that the pressure switch operates as intended by using an accurate pressure gauge connected upstream of the switch.
4. Replace the cover.

Automatic Reset

The NC contact of the switch breaks when pressure rises above the set point. The switch resets automatically when pressure falls below set point.

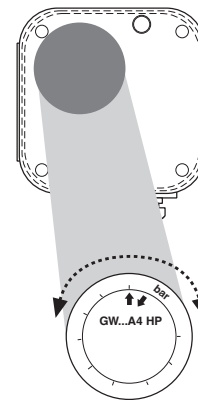

Installation Position

	Standard installation position is vertical upright diaphragm.
	The pressure switch is activated at a higher pressure when mounted horizontally: GW 500 HP SGS ca. + 0.01 bar GW 2000 HP SGS ca. + 0.02 bar GW 6000 HP SGS ca. + 0.08 bar
	The pressure switch is activated at a lower pressure if mounted horizontally overhead: GW 500 HP SGS ca. - 0.01 bar GW 2000 HP SGS ca. - 0.02 bar GW 6000 HP SGS ca. - 0.08 bar
	Intermediate mounting position GW 500 HP SGS ca. ± 0.01 bar GW 2000 HP SGS ca. ± 0.02 bar GW 6000 HP SGS ca. ± 0.08 bar

Dimensions

Dimensions in millimeters

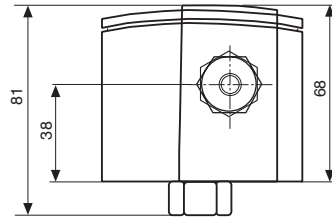

4 self-aligning pan-head screws M3x14
0.8 slot and DIN 7962-Z Phillips head

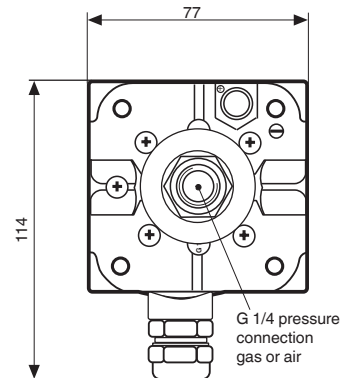
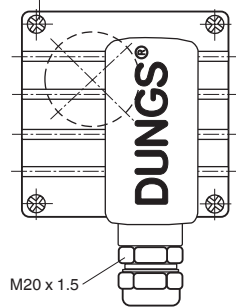

Maintenance & Testing

Annually check the switch for proper operation Set Point Calibration

- Connect a meter capable of reading +/- 0.1 ohms to the NC and COM contacts.
- Measure the resistance across the NC and COM contacts. If the resistance is more than 1.0 ohm, the switch should be replaced, since this indicates that the switch contacts are starting to either corrode or carbonizing.
- Apply pressure to the + air pressure connection, and confirm that the NC contact breaks when pressure rises above the set point and that the NO contact makes. The NC contact will make automatically when pressure falls below the set point pressure.
- Connect a meter capable of reading +/- 0.1 ohms to the NO and COM contacts.
- Measure the resistance across the NO and COM contacts. If the resistance is more than 1.0 ohm, the switch should be replaced, since this indicates that the switch contacts are starting to either corrode or carbonizing.

Accessories & Replacement

Accessory for pressure switch	Order No.
1/4 G to 1/4" NPT adapter with gasket	231944

We reserve the right to make modifications in the course of technical development.



Karl Dungs, Inc.
3890 Pheasant Ridge Drive NE
Suite 150
Blaine, MN 55449, U.S.A.
Phone 763 582-1700
Fax 763 582-1799
e-mail info@karldungsusa.com
Internet <http://www.dungs.com/usa/>

Karl Dungs GmbH & Co. KG
P.O. Box 12 29
D-73602 Schorndorf, Germany
Phone +49 (0)7181-804-0
Fax +49 (0)7181-804-166
e-mail info@dungs.com
Internet <http://www.dungs.com>